

## **Fuel Filter Maintenance - MX-13 EPA 2017**



---

# Contents

<b>Chapter 1: General Information.....</b>	<b>5</b>
Safety Alerts.....	6
Illustrations.....	6
General Safety Instructions.....	7
<b>Chapter 2: Fuel Filter.....</b>	<b>9</b>
Fuel Filter Recommended Tools.....	10
Chassis Mounted Fuel Filter Replacement.....	10
Engine Mounted Fuel Filter Removal.....	11
Engine Mounted Fuel Filter Installation.....	13
Priming the Fuel System.....	15
<b>Chapter 3: Fuel Recommendations.....</b>	<b>19</b>
Warranty and the Use of Renewable and Other Paraffinic Diesel Fuels.....	21
Warranty and the Use of Biodiesel Fuel.....	21
Recommendations to Avoid Fuel Gelling.....	21

**© 2021 PACCAR Inc. - All Rights Reserved**

This manual illustrates and describes the operation of features or equipment which may be either standard or optional on this vehicle. This manual may also include a description of features and equipment which are no longer available or were not ordered on this vehicle. Please disregard any illustrations or descriptions relating to features or equipment which are not on this vehicle. PACCAR reserves the right to discontinue, change specifications, or change the design of its vehicles at any time without notice and without incurring any obligation. The information contained in this manual is proprietary to PACCAR. Reproduction, in whole or in part, by any means is strictly prohibited without prior written authorization from PACCAR Inc.

---

# Chapter 1 | GENERAL INFORMATION

Safety Alerts.....	6
Illustrations.....	6
General Safety Instructions.....	7

## Safety Alerts

Read and follow all of the safety alerts contained in this manual. They are there for your protection and information. These alerts can help you avoid injury to yourself, your passengers, and help prevent costly damage to the vehicle. Safety alerts are highlighted by safety alert symbols and signal words such as “WARNING,” “CAUTION,” or “NOTE.” DO NOT ignore any of these alerts.

### Warnings



The safety message following this symbol and signal word provides a warning against operating procedures which could cause death or injury. They could also cause equipment or property damage. The alert will identify the hazard, how to avoid it, and the probable consequence of not avoiding the hazard.

Example:

 <b>WARNING</b>
Hot engine oil can be dangerous. You could be burned. Let the engine oil cool down before changing it. Failure to comply may result in death, personal injury, equipment or property damage.

### Cautions



The safety message following this symbol and signal word provides a caution against operating procedures which could cause equipment or property damage. The alert will identify the hazard, how to avoid it, and the probable consequence of not avoiding the hazard.

Example:

 <b>CAUTION</b>
Continuing to operate your vehicle with insufficient oil pressure will cause serious engine damage. Failure to comply may result in equipment or property damage.

### Notes



The message following this symbol and signal word provides important information that is not safety related but should be followed. The alert will highlight things that may not be obvious and is useful to your efficient operation of the vehicle.

Example:

 <b>NOTE</b>
Pumping the accelerator will not assist in starting the engine.

## Illustrations

Some of the illustrations throughout this manual are generic and will not look exactly like the engine or parts used in your application. The illustrations can contain symbols to indicate an action required and/or an acceptable or unacceptable condition.

The illustrations are intended to show repair or replacement procedures. The procedure will be the same for all applications, although the illustrations may differ.

## General Safety Instructions



### WARNING

Improper practices, carelessness, or ignoring any warnings may cause property damage, personal injury, or death.



### WARNING

Manually rotating the crankshaft requires a trained technician and specialty tools. DO NOT pull or pry on the fan in an attempt to rotate the crankshaft. Applying force to the fan can damage the fan blades or cause premature fan failure. Failure to comply with the approved procedure may result in property damage, personal injury, or death.

Before performing any repair, read and understand all of the safety precautions and warnings. The following is a list of general safety precautions that must be followed to provide personal safety. Failure to follow these instructions may cause death or injury. Special safety precautions are included in the procedures when they apply.

Keep in mind that even a well maintained vehicle must be operated within the range of its mechanical capabilities and the limits of its load ratings. See the Weight Ratings label on the driver's door edge.

Every new vehicle is designed to conform to all Federal Motor Vehicle Safety Standards applicable at the time of manufacture. Even with these safety features, continued safe and reliable operation depends greatly upon regular vehicle maintenance. Follow the maintenance recommendations found in the Preventive Maintenance section. This will help preserve your investment.

Make sure your vehicle is in top working condition before heading out on the road, it is the responsible driver's duty to do so. Inspect the vehicle according to the Driver's Check List.

- Work areas should be dry, well lit, well ventilated, free from clutter, loose tools, parts, ignition sources and hazardous substances.
- Wear protective glasses and protective shoes when working.
- DO NOT wear loose-fitting or torn clothing. Tie back and/or tuck in long hair. Remove all jewelry when working.
- Before beginning any repair, disconnect the battery (negative [-] cable) and discharge any capacitors.
- Put a "DO NOT OPERATE" tag in the operator's compartment or on the controls.
- Allow the engine to cool before slowly loosening the coolant fill cap to relieve the pressure from the cooling system.



### WARNING

Removing the fill cap on a hot engine can cause scalding coolant to spray out and burn you badly. If the engine has been in operation within the previous 30 minutes, be very careful in removing the fill cap. Protect face, hands, and arms against escaping fluid and steam by covering the cap with a large, thick rag. DO NOT try to remove it until the surge tank cools down or if you see any steam or coolant escaping. Always remove the cap very slowly and carefully. Be ready to back off if any steam or coolant begins to escape. Failure to comply may result in death, personal injury, equipment or property damage.

- Always use wheel chocks or proper jack stands to support the vehicle or vehicle components before performing any service work. DO NOT work on anything that is supported only by lifting jacks or a hoist. Before resting a vehicle on jack stands, be sure the stands are rated for the load you will be placing on them.
- Before removing or disconnecting any lines, fittings, or related items, relieve all pressure in the air, oil, fuel, and cooling systems. Remain alert for possible pressure when disconnecting any device from a system that contains pressure. High pressure oil or fuel can cause death or personal injury.
- Always wear protective clothing when working on any refrigerant lines and make sure that the workplace is well ventilated. Inhalation of fumes can cause death or personal injury. To protect the environment, liquid refrigerant systems must be properly emptied and filled using equipment that prevents the release of refrigerant gas. Federal law requires capturing and recycling refrigerant.
- When moving or lifting any heavy equipment or parts, make sure to use proper techniques and assistance. Ensure all lifting devices such as chains, hooks, or slings are in good condition and are of the correct load capacity. Make sure all lifting devices are positioned correctly.
- Corrosion inhibitors and lubricating oils may contain alkali. DO NOT get the substance in eyes and avoid prolonged or repeated contact with skin. DO NOT swallow. If ingested, seek immediate medical attention. DO NOT induce vomiting. In case of contact, immediately wash skin with soap and water. In case of harmful contact, immediately contact a physician. Always keep any chemicals OUT OF REACH OF CHILDREN.

- Naphtha and Methyl Ethyl Ketone (MEK) are flammable materials and must be used with caution. Follow the manufacturer's instructions to ensure safety when using these materials. Always keep any chemicals OUT OF REACH OF CHILDREN.
- When working on the vehicle, be alert for hot parts on systems that have just been turned off, exhaust gas flow, and hot fluids in lines, tubes, and compartments. Contact with any hot surface may cause burns.
- Always use tools that are in good condition. Make sure you have the proper understanding of how to use the tools before performing any service work. Use only genuine replacement parts from PACCAR.
- Always use the same fastener part number (or equivalent) when replacing items. DO NOT use a fastener of lesser quality if replacements are necessary. (e.g., DO NOT replace a SAE 10.9 grade with 8.8 grade fastener.)
- Always torque fasteners and fuel connections to the required specifications. Overtightening or under-tightening can allow leakage.
- Close the manual fuel valves prior to performing maintenance and repairs, and when storing the vehicle inside.
- DO NOT perform any repair when impaired, tired, fatigued, or after consuming alcohol or drugs that can impair your functioning.
- Some state and federal agencies in the United States of America have determined that used engine oil can be carcinogenic and can cause reproductive toxicity. Avoid inhalation of vapors, ingestion, and prolonged contact with used engine oil.
- DO NOT connect the jump starting or battery charging cables to any ignition or governor control wiring. This can cause electrical damage to the ignition or governor.
- Coolant is toxic. If not reused, dispose of coolant in accordance with local environmental regulations.

**CAUTION**

Corrosive chemicals can damage the engine. DO NOT use corrosive chemicals on the engine. Failure to comply may result in equipment or property damage.

**California Proposition 65 Warning**

- Diesel engine exhaust and some of its constituents are known to the State of California to cause cancer, birth defects, and other reproductive harm.
- The catalyst substrate located in the Diesel Particulate Filter (DPF) contains vanadium pentoxide, which has been determined by the State of California to cause cancer. Always wear protective clothing and eye protection when handling the catalyst assembly. Dispose of the catalyst in accordance with local regulations. If catalyst material gets into the eyes, immediately flood eyes with water for a minimum of 15 minutes. Avoid prolonged contact with skin. In case of contact, immediately wash skin with soap and water. In case of harmful contact, immediately contact a physician.
- Other chemicals in this vehicle are also known to the State of California to cause cancer, birth defects or other reproductive harm.
- Battery posts, terminals, and related accessories contain lead and lead compounds, chemicals known to the State of California to cause cancer and reproductive harm. Wash hands after handling.



---

## Chapter 2 | FUEL FILTER

Fuel Filter Recommended Tools.....	10
Chassis Mounted Fuel Filter Replacement.....	10
Engine Mounted Fuel Filter Removal.....	11
Engine Mounted Fuel Filter Installation.....	13
Priming the Fuel System.....	15

Perform these maintenance procedures when indicated by the Preventative Maintenance Schedule.

**WARNING**

When removing the fuel filter, a quantity of fuel will escape. DO NOT smoke or allow an open flame in close proximity. Failure to do so could ignite a fire or cause an explosion which could result in serious injury to you and/or bystanders. Failure to comply may result in death, personal injury, equipment or property damage.

**CAUTION**

Replace fuel filters with parts of the same part number. PACCAR periodically changes its filter design, and filters of different part numbers are not interchangeable. Use of incorrect filter part numbers or non-genuine filters can result in low pressure fuel fault codes and/or severe engine damage. Contact a Kenworth or Peterbilt dealer to verify the correct fuel filter part numbers.

**NOTE**

The fuel filter and the hand pump are located on the left-hand side of the engine, as viewed from the driver's seat.

**NOTE**

Use of poor quality fuel may require more frequent fuel filter element service.

**Description**

The fuel filter/water separator module provides fine-particle filtration, water separation, water-in-fuel sensing, 12V preheating and system manual priming in a singular easy to service module.

Replace the suction side and the pressure side fuel filters at the same time. It is recommended to replace the fuel filters at the same interval as the oil and oil filter are changed. If the oil drain interval being used is greater than 15,000 mi (24,000 km), as determined by the Engine Lubrication and Filter Intervals, the fuel filter change can be extended until the oil drain interval.

**Biodiesel**

For information on alternative fuels, such as biodiesel, and additional information for fuel recommendations and specifications refer to "Fuels for Cummins® Engines," Bulletin 3379001.

For information on alternative fuels, such as biodiesel, and additional information for fuel recommendations and specifications, see [Warranty and the Use of Biodiesel Fuel](#) on page 21.

**Fuel Filter Recommended Tools**

The following tools are recommended for replacing fuel filters:

- Container suitable to drain diesel fuel into
- Fuel filter bowl wrench (as appropriate for the specific application)
- 32mm hexagonal socket
- Torque wrench capable of 30 lb-ft ± 6 (40 N·m ± 8)
- Sufficient clean diesel fuel to lubricate filter seals and fill the chassis mounted filter bowl
- Clean, lint-free cleaning cloths
- Mity-Vac Fuel Priming/Bleeding kit available through PACCAR dealers (optional but highly recommended)

**Chassis Mounted Fuel Filter Replacement**

Refer to supplier manuals for fuel filter replacement instructions.

- DAVCO documentation is available at <http://www.davcotec.com/documents.htm>.
  - RACOR documentation is available at <https://www.parker.com>.
1. Turn off the engine and allow it to cool until it can be touched.

- If equipped with a fuel blender, turn the blender 90° counterclockwise to the prime position (2). The valve only rotates 90° left or right.

Figure 1: PACCAR Fuel Blending Valve Position

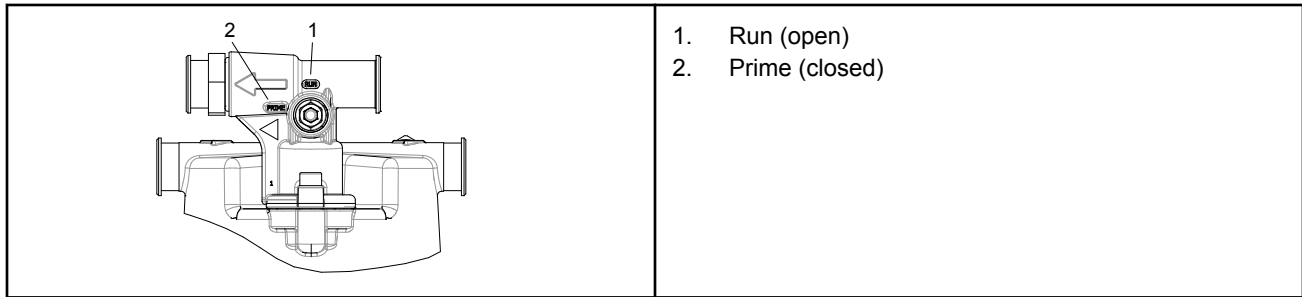

- If equipped, disconnect the water-in-fuel sensor and heater connectors (2 and 4).
- Clean the area around the filter to prevent debris from falling into the filter bowl during the filter change.
- Drain the fuel from the fuel filter into a suitable container by opening the manual drain valve located at the bottom of the filter housing (3).

Figure 2: PACCAR Branded Chassis Fuel Filter

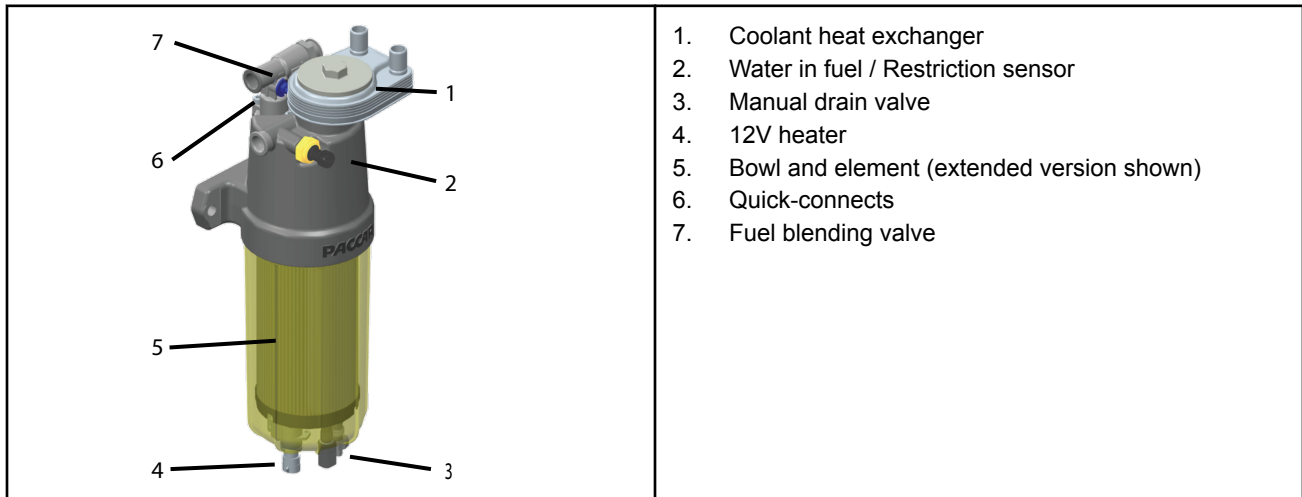

- Remove the filter bowl (5). A filter bowl wrench may be required. Dispose of the filter appropriately.
- Clean the filter bowl.
- Lubricate the new filter seals with clean diesel fuel and install the seals with the new filter.
- To aid in priming, pre-fill the filter bowl with clean diesel fuel.
- Slowly, so as not to spill fuel from the filter bowl, raise the filter bowl up to the filter housing.
- Tighten the filter bowl snugly by hand or using the filter bowl wrench.
- If equipped, connect the water-in-fuel sensor and heater connectors.
- Prime the fuel system. See [Priming the Fuel System](#) on page 15.
- Check for leaks. Correct leaks as needed with the engine off.
- Allow the engine to idle for 5 minutes.
- Turn the engine off.
- Proceed to [Engine Mounted Fuel Filter Removal](#) on page 11.

## Engine Mounted Fuel Filter Removal

Follow the steps below to remove the fuel filter:

PACCAR has published a video on YouTube to help you understand how to replace the engine mounted fuel filter. Please scan the QR code below or go to <https://youtu.be/VVjJQ7TojIw>.



 CAUTION

Failure to prime any new (dry) fuel filter can cause severe engine damage due to dry starting the engine. Please refer to the priming procedure and follow it carefully after installing new filter cartridges and before starting the engine.

 CAUTION

To prevent damage to the fuel filter element, keep it in its original packaging until you are ready to install it.

1. Clean the fuel tank filler cap and the surrounding area. Remove the fuel tank filler cap to prevent overpressure in the fuel system.
2. If equipped with a fuel blender, turn the blender 90° counterclockwise to the prime position (2). The valve only rotates 90° left or right.

Figure 3: PACCAR Fuel Blending Valve Position

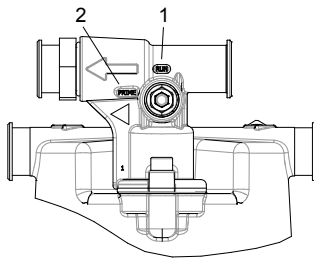

1. Run (open)
2. Prime (closed)

3. Clean the fuel filter screw cap (1) and surrounding area with a clean rag to ensure dirt does not fall into the fuel module (4).

**CAUTION**

Dirt in the fuel system can lead to significant damage to the fuel system. Failure to comply may result in equipment or property damage.

Figure 4: Fuel Filter Module

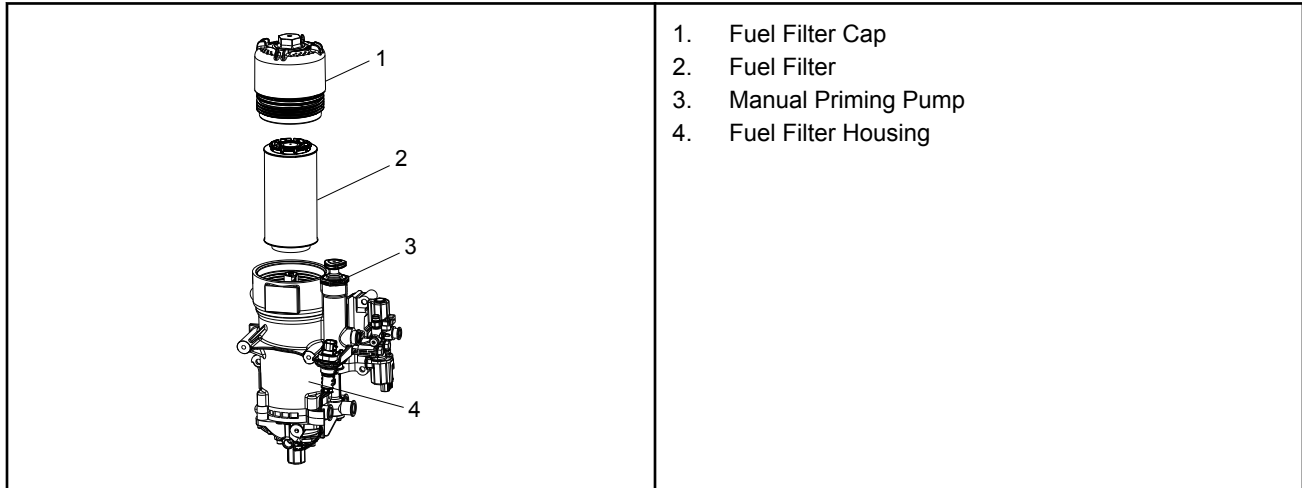

1. Fuel Filter Cap
2. Fuel Filter
3. Manual Priming Pump
4. Fuel Filter Housing

4. Remove the fuel filter cap (1) by rotating it counterclockwise with a 32mm hexagonal socket or box wrench. Automatic draining of fuel will be initiated. Wait 5 minutes for complete fuel draining before fully removing the filter screw cap.
5. After the module has drained, fully remove the filter screw cap (1).
6. Carefully pull the fuel filter element (2) straight off from the fuel filter screw cap (1).
7. Remove the O-ring (2) from the fuel filter screw cap and discard the filter cartridge and O-ring.

**NOTE**

The fuel filter cartridge is a disposable filter and must not be cleaned and reused. Dispose of the filter as chemical waste.

8. Clean the O-ring groove and threads.
9. Clean the fuel bowl and filter housing of any sediment or debris.

## Engine Mounted Fuel Filter Installation

Follow the steps below to install new fuel filters:

**CAUTION**

Failure to prime any new (dry) fuel filter can cause severe engine damage due to dry starting the engine. Please refer to the priming procedure and follow it carefully after installing new filter cartridges and before starting the engine.

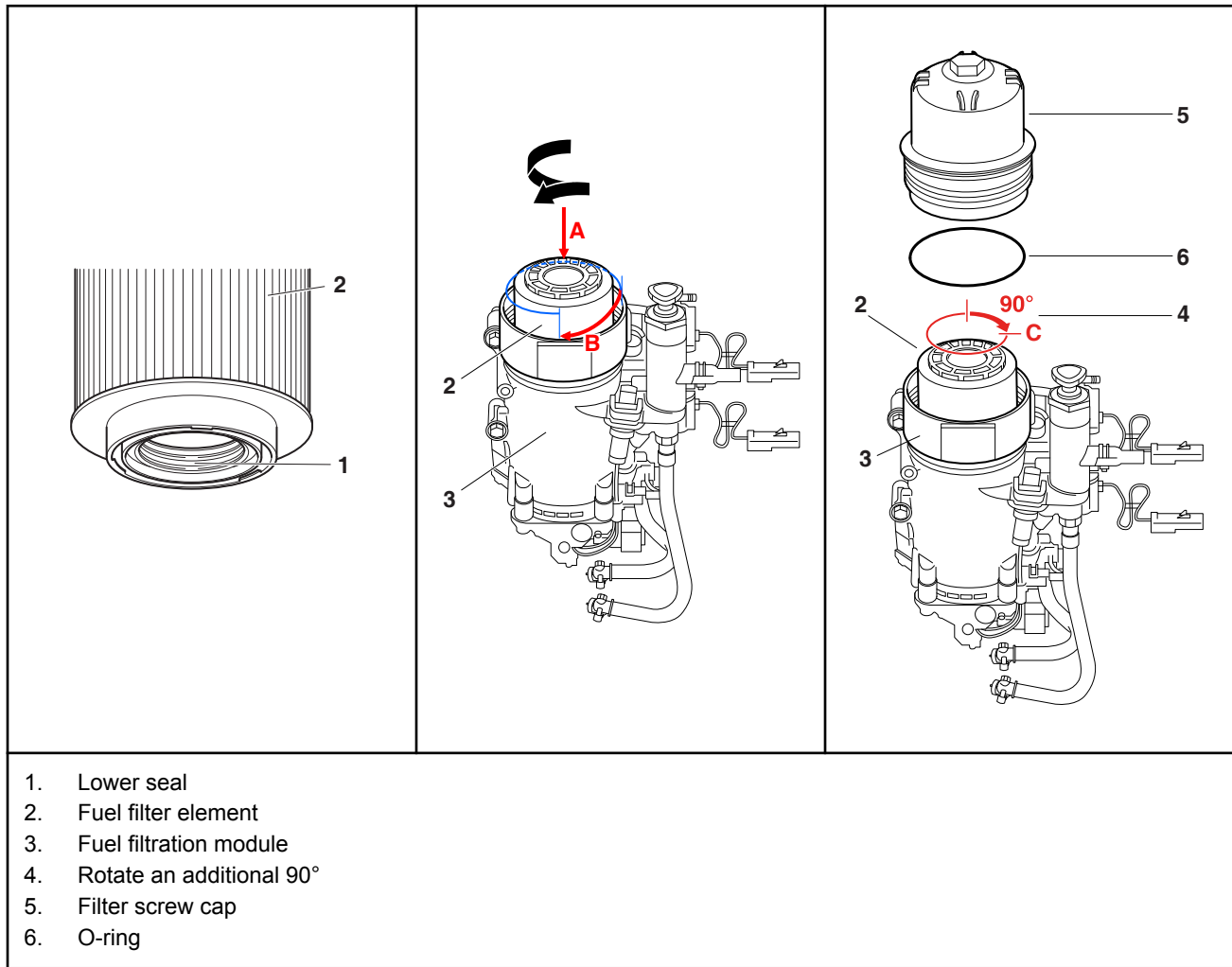

1. Lower seal
2. Fuel filter element
3. Fuel filtration module
4. Rotate an additional 90°
5. Filter screw cap
6. O-ring

1. If the seal (1) inside the fuel filter element (2) is not lubricated, lubricate the seal with clean engine oil or clean diesel fuel.

**CAUTION**

Ensure that the engine oil, diesel fuel, and your hands are clean. Introducing dirt into the fuel system can result in failure of fuel system components.

**NOTE**

If using fuel filter part number 2277129, the seal (1) is pre-lubricated and does not require additional lubrication. The lubrication may appear to be a white film.  
 If using fuel filter part number 1852006, 2133096, or 2164463, ensure that seal (1) is lubricated with clean engine oil or clean diesel fuel.

2. Insert the fuel filter element (2) into the fuel filtration module (3) using a circular downward motion until the stop is reached.
3. Rotate the fuel filter element (2) an additional 90° (4) in the fuel filtration module.
4. Lubricate the recess of the filter screw cap (5) with clean engine oil.
5. Install a new O-ring (6) on the filter cap and lubricate it with clean engine oil.
6. Install the fuel filter cap (5) by hand until the filter cap O-ring (6) makes contact with the fuel module (3). Then, using a hexagonal socket and torque wrench, tighten the filter cap to 30 lb-ft ± 6 (40 N·m ± 8).



## NOTE

Depending on the vehicle's fuel system configuration, the fuel filter housing may not completely drain of fuel. If this is the case, take care when installing the new filter as this may cause fuel to spill from the filter housing.

7. If available, using a vacuum pump, apply vacuum to the engine's fuel return port for 7 minutes, then reconnect the return line.



## NOTE

Do not operate the engine with a vacuum pump attached or with the return line disconnected. Injector damage could occur.

8. Prime the fuel system thoroughly using the hand primer pump. See [Priming the Fuel System](#) on page 15.

## Priming the Fuel System

To start the engine after the fuel tank has run dry, or after the fuel system service has been performed, follow the steps below:

**CAUTION**

The following instructions should be used in emergency situations when the fuel tank has run dry, or after the fuel system service has been performed. Failure to follow the starting instructions below may damage the starter motor.

Figure 5: Fuel Filter Module - Priming Pump

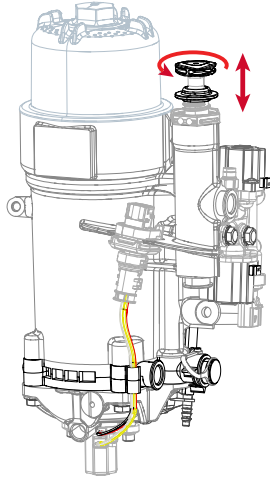

Figure 6: Fuel Filter Module - Priming Pump

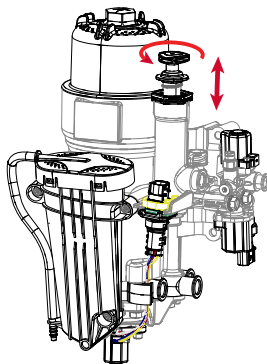
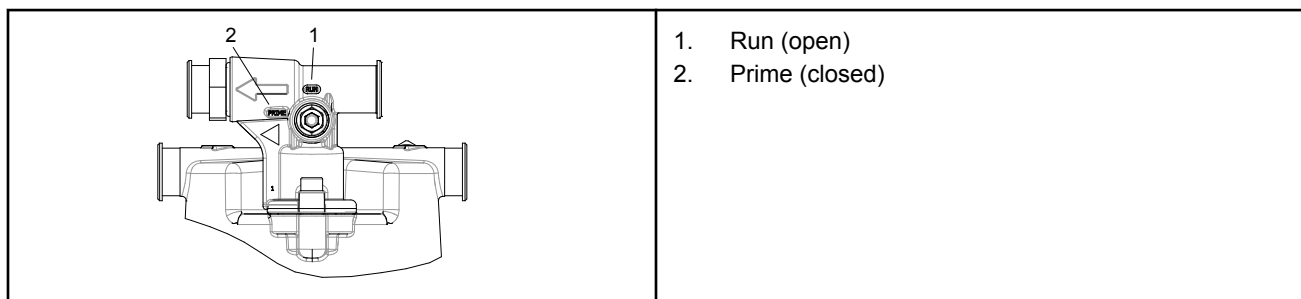

Figure 7: PACCAR Fuel Blending Valve Position



1. Loosen the fuel primer pump knob by rotating it counterclockwise.
2. If your vehicle is equipped with a PACCAR fuel blending valve, rotate the blending valve 90° counterclockwise to the PRIME (closed) position (see "PACCAR Fuel Blending Valve Position") before starting the priming procedure. The valve only rotates 90° left or right. Whether or not your vehicle is equipped with a PACCAR fuel blending valve, continue to Step 3.
3. Operate the priming pump by moving the knob in and out for 150 seconds. During this time the pumping resistance will increase, indicating air is being bled from the system. The full time is required to fully prime the fuel system.



**CAUTION**

Operate priming pump at a maximum rate of 30 strokes per minute to prevent damage to pump.

4. Check for leakage at the fuel filter cap. Tighten if necessary.

**WARNING**

Check the fuel filter for signs of leakage. DO NOT smoke or allow an open flame in close proximity. Failure to do so could ignite a fire or cause an explosion which could result in serious injury to you and/or bystanders. Failure to comply may result in death, personal injury, equipment or property damage.

5. Wait for 60 seconds and then operate the priming pump 25 more strokes.
6. Start the engine and allow it to idle for 5 minutes. Note that it could take up to 15 seconds of cranking for the engine to start. If the starter is engaged for longer than 20 seconds without starting, additional priming pump actuation may be necessary.

**CAUTION**

If the engine is cranked excessively, Starter Protection will be triggered and starter engagement will be restricted for 10 minutes.

**NOTE**

Allowing the engine to idle for several minutes with the PACCAR fuel blending valve in the prime (closed) position assists in purging air from the fuel system.

7. Check the system for leakage while idling.
8. Turn the engine OFF and check the system again for leakage.
9. If the engine does not start within this time, repeat steps two and three until the engine starts. If the engine still does not start, allow the starter to cool down for at least 5 minutes before repeating the procedure.
10. If equipped with a PACCAR fuel blending valve, turn the valve 90° clockwise to the RUN (open) position. The valve only rotates 90° left or right.

**NOTE**

Failure to return the PACCAR fuel blending valve to the RUN (open) position will prevent fuel recirculation and heating.

**WARNING**

DO NOT loosen any fuel line fittings in order to bleed the fuel system of air. The system is under high pressure which, when relieved, could cause death, personal injury, equipment or property damage.



---

# Chapter 3 | FUEL RECOMMENDATIONS

Warranty and the Use of Renewable and Other Paraffinic Diesel Fuels..... 21  
Warranty and the Use of Biodiesel Fuel..... 21  
Recommendations to Avoid Fuel Gelling.....21

**WARNING**

The use of diesel fuel that has been mixed with other fuels may cause an explosion. DO NOT mix gasoline, alcohol, or gasohol with diesel fuel. Make sure you know your fuel source and use the recommended diesel fuel as indicated in this section of the manual. Failure to comply may result in death, personal injury, equipment or property damage.

**CAUTION**

Dirt or water in the fuel system can cause severe damage to both the fuel pump and the fuel injectors. Due to the precise tolerances of diesel injection systems, it is extremely important that the fuel be kept clean and free of dirt or water. Know your fuel source and make sure all steps are taken for dispensing or using clean fuel in your vehicle. Failure to comply may result in equipment or property damage.

**CAUTION**

Unapproved fuel can reduce economy or possibly damage fuel system components. Unapproved fuels typically do not have enough lubricity elements in the fuel to properly lubricate the fuel injection system. Be sure you follow the fuel recommendations as indicated in this section of the manual. Failure to comply may result in equipment or property damage.

**CAUTION**

Using diesel fuels blended with lubricants may cause damage to your engine aftertreatment system. Service intervals for engine aftertreatment systems will be reduced. DO NOT use diesel fuel blended with lubricating oil in engines equipped with an engine aftertreatment system. Failure to comply may result in equipment or property damage.

**CAUTION**

DO NOT use high-sulfur diesel fuel as it will damage the exhaust aftertreatment system. Also, the engine will not meet emission regulations. Use only ultra-low-sulfur diesel (ULSD) fuel. Failure to comply may result in equipment or property damage.

**CAUTION**

If ultra-low-sulfur diesel (ULSD) fuel is not used, the engine may not meet emission regulations, and damage may occur to the engine aftertreatment system. The use of high-sulfur diesel fuel will damage the engine aftertreatment system and impact the engine emission. ULSD fuel is required for correct operation of the aftertreatment. The engine has been optimized for use with an engine aftertreatment system together with ULSD fuel to meet the 2013 U.S. Environmental Protection Agency regulations. Failure to comply may result in equipment or property damage.

**NOTE**

PACCAR recommends that the cetane number of diesel fuel be a minimum of 45 for engines that are expected to operate at temperatures below 32°F (0°C) and a minimum of 42 for engines that are operated at temperatures above 32°F (0°C).

Using diesel fuel with a lower-than-recommended cetane number can cause hard starting instability, and excessive white smoke. To maintain satisfactory operation at low ambient temperatures, it is important to specify diesel fuel of the correct cetane number.

PACCAR requires all permissible fuels to have adequate fuel lubricity. Lubricity can be determined by ASTM, specification D6079, ISO 12156, High Frequency Reciprocating Rig (HFRR) in which the fuel must have a wear scar diameter of 0.02 in. (0.5 mm) or less.

The use of Ultra-low-sulfur diesel (ULSD) fuel is required for this engine in order to meet emission regulations and to prevent damage to the engine and exhaust system. The use of other grades of diesel fuels other than ULSD fuel will be considered a use of incorrect fuel for the engine. PACCAR is not responsible for failures caused by the use of incorrect fuel, oil or DEF or by water, dirt or other contaminants in the fuel or DEF.

## Warranty and the Use of Renewable and Other Paraffinic Diesel Fuels

PACCAR Inc. approves the use of paraffinic diesel at any blend level or as a stand-alone fuel, providing that the following conditions are met:

- The paraffinic diesel in the fuel meets EN 15940 specifications, and
- The finished fuel meets the properties of ASTM Standard D975

The use of approved paraffinic diesel fuel does not affect the PACCAR engine warranty, or its maintenance intervals. Failures caused by the use of fuels that are not approved, are of unacceptable quality, or do not meet specified industry standards are not considered as defects of parts or workmanship by PACCAR and therefore will not be covered by the PACCAR engine warranty. Specifically, raw or unprocessed vegetable oils differ heavily from paraffinic diesel and are not approved.

PACCAR recommends that customers intending to use paraffinic diesel become familiar with the properties of these fuels. Please reference the fuel supplier's technical information and request a copy of the certificate of analysis if it is unclear whether the fuel meets specifications. In particular, operators should be aware that paraffinic fuels are more prone to cold flow (gelling) and filter plugging issues if not formulated to meet climate-dependent requirements for the region. Operators should also be aware that paraffinic diesel energy content (by volume) is lower than that of petroleum diesel, which can reduce fuel economy by up to four percent as a stand-alone fuel.

## Warranty and the Use of Biodiesel Fuel

PACCAR Inc. approves the use of biodiesel fuel blends up to 20 percent by volume in diesel fuel providing that the following conditions are met:

- The biodiesel used in the blend meets ASTM Standard D6751 or EN 14214 specifications.
- The biodiesel used in the blend is sourced from a BQ-9000 Accredited Producer.
- The finished blend meets the fuel properties of the ASTM Standard D975 (up to B5 blend) or D7467 (B6 to B20 blend).
- If using B6-B20 the engine oil and oil filter are changed per the modified schedule. See the Preventative Maintenance Schedule.
- If using B6-B20 the fuel filter is changed every 25,000 miles (40,000 km).

The use of approved biodiesel fuel does not affect the PACCAR engine warranty. Failures caused by the use of non-approved biodiesel fuels or other fuel additives that are of unacceptable quality or do not meet specified industry standards are not considered as defects of parts or workmanship by PACCAR and therefore will not be covered by the PACCAR engine warranty.

PACCAR recommends that customers intending to use biodiesel blends become familiar with the additional handling considerations of these fuels such as aging, metal compatibility and tendency to absorb water. Please reference the fuel supplier's technical information or industry guidelines such as the American Trucking Association Truck Maintenance Council document RP 357.

In particular, operators should be aware that biodiesel blends are more prone to cold flow (gelling) and filter plugging issues compared to conventional diesel fuel. If vehicles are expected to be operated in temperatures below freezing, care should be taken to ensure that both the biodiesel fuel used and the appropriate vehicle fuel system accessory heaters are utilized.

Operators should also be aware that biodiesel energy content (by volume) is lower than diesel which can reduce fuel economy by up to two percent.

## Recommendations to Avoid Fuel Gelling

To avoid fuel gelling in cold weather:

- Use appropriate fuel grade/blend for conditions
- Spec your vehicle with proper cold weather equipment (12V electric pre-heater, fuel/coolant heater, 12V fuel line heaters and fuel tank heaters)

PACCAR does not recommend the use of fuel additives, however, should a customer decide there is a need for temporary use of a winter fuel additive, PACCAR offers the following guidance:

- Use an industry known, high quality product (EPA-approved)
- Check the product label to ensure it is compatible with ultra-low sulfur diesel fuel and aftertreatment systems
- Only use the additive for the minimum time needed
- Follow the additive manufacturer's instructions exactly

# Index

## B

Biodiesel

## D

Diesel Fuel

## F

Filters [11](#), [13](#)  
Fuel Filter  
Fuel Filter Installation [13](#)  
Fuel Filter Removal [11](#)  
Fuel Gelling [21](#)  
Fuel Recommendations  
Fuel System Priming [15](#)

## G

General Safety Instructions [7](#)

## I

Illustrations [6](#)  
Install Fuel Filter [13](#)

## P

Priming the Fuel System [15](#)

## R

Recommendations to avoid fuel gelling in cold temperatures [21](#)  
Remove Fuel Filter [11](#)  
Run Out of Fuel [15](#)

## S

Safety Alerts [6](#)  
Starting After the Fuel Tank Has Run Dry [15](#)

## U

ULSD  
Ultra-Low Sulfur Diesel

## W

Warranty and the Use of Biodiesel Fuel [21](#)  
Warranty and the Use of Renewable and Other Paraffinic Diesel Fuels [21](#)

